

Heat recovery with plate heat exchanger

Concerning the freezing of condensate

European Regulation EU 1253-2014 stipulates a minimum temperature efficiency of 0.73 for plate heat exchangers from 1.1.2018. With this high efficiency, there is an increased possibility that any condensate from the extract air will be significantly cooled down and frozen: The danger of freezing increases. Every ventilation specialist should know whether and, if so, how this is to be taken into account during planning and implementation.

1. What freezes, and when?

If moist air is cooled, the relative humidity increases until ultimately the liquid condensate freezes at temperatures below freezing point. This process is typical for heat recovery from extract air at low outdoor temperatures:

The heat of the extract air is transferred to the cold fresh air; this cools down the extract air. Depending on the moisture content, condensate Δx is formed (Figure 1). This releases heat, which significantly improves the efficiency of the heat transfer, i.e. the temperature efficiency RWZ. At the same time, however, the condensate on the extract air side also reduces the flow cross-section and thus increases the pressure drop. If the fresh air is so cold that the extract air is cooled below the freezing point of the condensate, it can freeze and block the heat exchanger on the extract air side partially - or in extreme cases even completely. The extract air output decreases or even goes to zero. Heat recovery is also reduced accordingly, i.e. preheating of the fresh air is reduced. The reduced output must be compensated by a larger reheater.

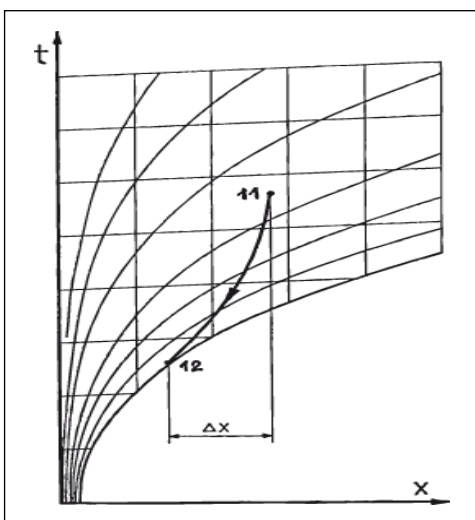

Figure 1: Condensate from the extract air can freeze if the unit cools significantly

This physical process is basically the same for all heat recovery systems, i.e. plate heat exchangers, rotors, heat pipes and circulation systems. The freezing limit, which is the minimum permissible outdoor air temperature at which freezing does not yet occur, is different however, and depends on:

- The extract air conditions (temperature t_{11} and humidity rF_{11} or x_{11}),
- The (dry) temperature efficiency of the heat recovery unit RWZ
- The mass flow ratio ($m_2 : m_1 = \text{cold air} : \text{warm air}$)
- The exchanger design

Because of the relatively high temperature efficiency, but also because of the uneven temperature distribution, the cross-flow plate heat exchanger is particularly interesting with regard to this physical phenomenon.

2. Calculation of the frost limit of the plate heat exchanger

The consideration is based on cross-flow exchangers, in which air flows through all plates uniformly and thus the same conditions exist for all plates. (Since cross and counter flow occur with the so-called counter flow unit, the calculation is analogous.) The cross-flow principle means that the cold fresh air is unequally heated or cooled like the warm extract air, which makes the calculation difficult. However, if the panels are divided into equal elements (e.g. 10 x 10), the thermal process can be calculated relatively easily, as can the condensation that occurs. This calculation using the finite element method also clearly shows the so-called cold corner of the plate heat exchanger; this is where the extract air is cooled the most.

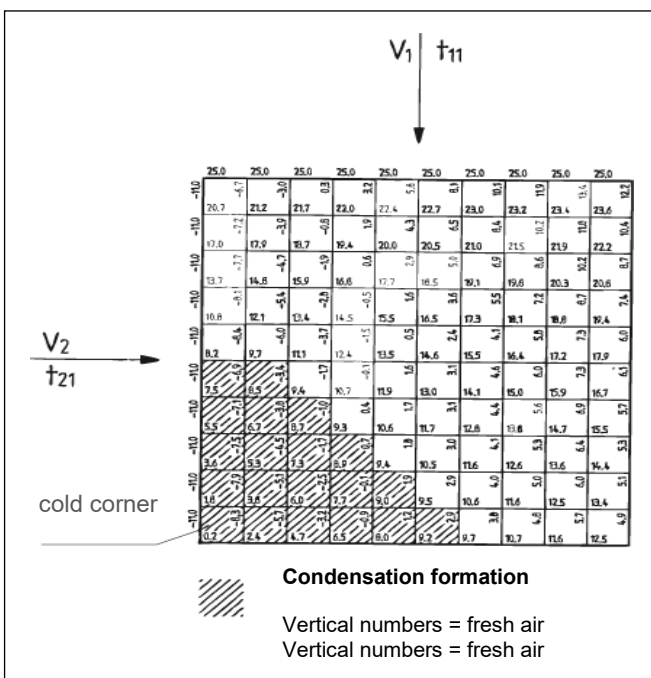

Figure 2: Temperature curve of a plate heat exchanger, calculated using the finite element method

If the temperature of the fresh air is varied in such a way that the temperature of the extract air at this element is just 0 °C, given constant conditions of the extract air, the theoretical freezing limit has been found (Figure 2). This approach produces results that are largely confirmed in practice. (It would be physically more correct to set the temperature of the condensate to zero, for which purpose the condensate transport in the exchanger – depending on the installation position and the air flow – would have to be taken into account.)

This calculation model is therefore based on the following simplifications:

- Extract air temperature and condensate temperature are the same.
- Heat transfer from the condensate to the plate is infinite, i.e. the condensate temperature is equal to the plate temperature.
- The heat capacity of the condensate is not taken into account.
- Conversion energy liquid/solid of the condensate is not considered.

This calculation method can be used to calculate any concrete case, but of course also the general behaviour of the plate heat exchanger.

t11	rF11	Dry temperature efficiency			
°C	%	0.50	0.60	0.7	0.8
20	30	-13.4	-11.4	-7.8	-5.6
	50	-15.9	-13.2	-9.7	-7.4
	70	-18.8	-16.3	-11.4	-9.4
25	30	-16.3	-13.4	-9.5	-6.9
	50	-19.6	-17.2	-12.1	-9.4
	70	-23.4	-20.1	-14.0	-12.6

Table 1: Freezing limit of a cross-flow unit as a function of extract air temperature t_{11} , relative extract air humidity rF_{11} and temperature efficiency Φ at a mass flow ratio $m_2/m_1 = 1.0$

Table 1 lists the minimum permissible outdoor temperatures (= freezing limits) for a cross-flow unit under various extract air conditions. This reveals the following connections:

- The risk of freezing decreases with increasing humidity. This has a particularly strong effect at higher temperatures.
Attention: If the extract air humidity (at standard conditions) is less than 4 g/kg, the dew point is < 0 °C, i.e. condensation does not occur. The water vapour immediately changes from a gaseous to a solid state and sublimates (→ it "snows"). In order to freeze, the humidity of the extract air must therefore be more than 4 g/kg air.
- The higher the efficiency of the plate heat exchanger, the higher the risk of freezing.
- The higher the extract air temperature, the lower the risk of freezing.
- The greater the mass flow ratio m_2/m_1 (cold air/hot air), the greater the risk of freezing (see Table 2: → A lot of cold air cools less warm air more strongly).

It is important for the evaluation of these calculation results that this is a theoretical consideration, the values of which can vary depending on the calculation model. In practice, therefore, deviations are to be expected.

3. Influences in practice

Practical applications reveal that the actual freezing behaviour also depends above all on three factors in addition to the physical boundary conditions.

- The operating behaviour of the extract air fan
- The mounting position and the air flow of the heat exchanger
- The design of the heat exchanger (Figure 8)

3.1 Fan characteristic of the extract air fan

The plate heat exchanger is considered if part of its surface is already frozen (Figure 3). The ice in the cold corner narrows the flow cross-section of the extract air towards the outlet, thereby increasing the pressure drop.

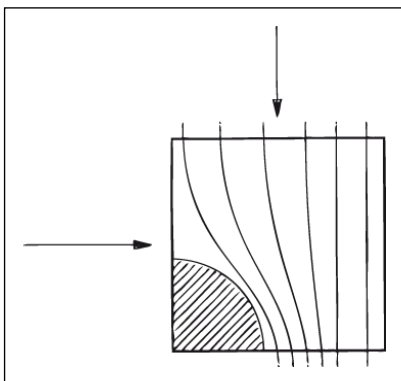

Figure 3: Extract air flow in a partially frozen plate heat exchanger

In the case of fans with flat characteristic curves – hardly used in practice any more – the flow rate decreases as a result, which leads to a deterioration of the mass flow ratio in the plate heat exchanger. The constantly large quantity of fresh air cools the now decreasing extract air more and more. Ice formation is accelerated and the heat exchanger finally freezes up completely. As a rule, it is not damaged; it will work again after thawing.

If a fan with a steep characteristic curve, e.g. with backward curved blades, is installed in the extract air flow (this is standard today – as of 2018), then even with a smaller flow cross-section, approximately the nominal extract air volume is still conveyed. Due to the higher flow velocity, the output is lower, and the mass flow ratio also changes in favour of the extract air flow in relation to the threatened cross-section. In practice, this means that a state of equilibrium is established depending on the outdoor temperature and that the heat exchanger does not usually freeze completely. The ventilation function is guaranteed – although with some limitations.

3.2 Mounting position and the air ducting

The theoretical calculation does not take into account the fact that the condensate in the heat exchanger is moved not only by gravity, but also by the flow forces. In principle, this can have two effects:

- At the beginning of condensation, the dew point temperature is still relatively high, so the condensate is warm and rich in energy. Compared to the air, the heat capacity of the water is also many times higher, so that a relatively large amount of energy is transported with the condensate. This means that colder parts of the plate heat exchanger can be kept warm if there is sufficient condensate.
- If the amount of condensate is small and the energy contained in it is not sufficient to heat the cold zones of the plate heat exchanger, the plate heat exchanger freezes faster due to the supply of condensate.

With this knowledge the following cases can be distinguished:

3.2.1 Normal configuration

Cross-flow plate exchangers are installed so that one air flow is vertical and the other horizontal. If duplicate symmetries are not taken into account, there are basically four flow possibilities (Figure 5) with the described effects.



			
<p>a) The condensate is conveyed into the cold zone by gravity and flow. If a lot of condensate precipitates, the risk of freezing is reduced. If little condensate precipitates, the freezing process is faster.</p>	<p>b) Gravity and flow act against each other. If gravity prevails, the condensate is returned to warmer zones, reducing the risk of freezing. If the flow force prevails, see a).</p>	<p>c) The condensate is transported to warmer zones by gravity and flow; the risk of freezing is lower.</p>	<p>d) The condensate is conveyed into the cold zone by gravity and flow, consequently the same as a).</p>
<p>1 = Giving off heat 2 = Absorbing heat</p>		<p> = Condensate  = Cold corner</p>	

Figure 4: Possible air ducting for the normal configuration

3.2.2 Diagonal configuration

With the usual diagonal configuration, the four flow possibilities are again considered (Figure 5).

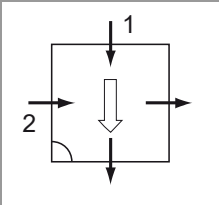
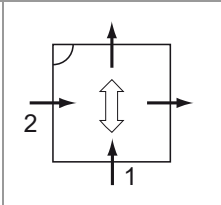
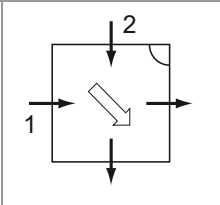
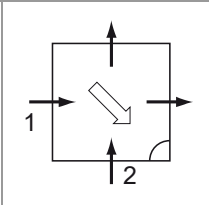
<p>a) The condensate is conveyed into the cold zone by gravity and flow. If a lot of condensate precipitates, the risk of freezing is reduced. If little condensate precipitates, the freezing process is faster.</p>		<p>b) The condensate is conveyed into the cold zone by gravity and flow. This increases the risk of freezing (unless a great deal of condensate precipitates).</p>	
<p>1 = Giving off heat 2 = Absorbing heat</p>		<p>→ = Condensate └ = Cold corner</p>	

Figure 5: Possible air ducting for the diagonal configuration

3.2.3 Counterflow unit

The so-called counterflow unit of heat recovery in ventilation technology consists of

- the inlet and outlet part with cross-flow characteristics
- the counterflow part in between

In keeping with its name, the air flows must be guided in a counterflow – in order to achieve high temperature efficiency. This reduces the number of air ducting pathways compared to a cross-flow unit.

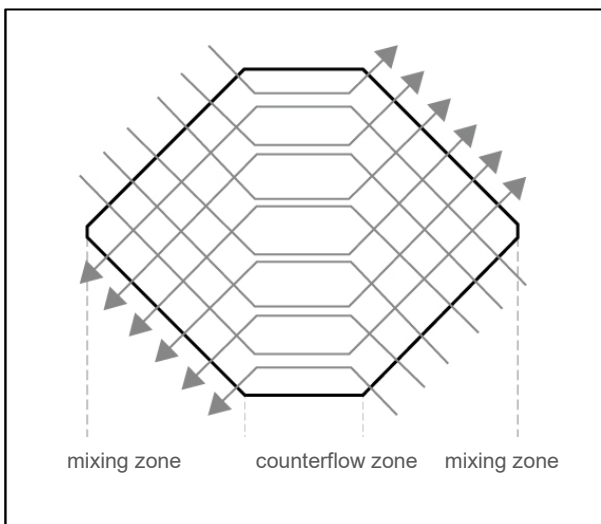

Figure 6: With this air ducting in the counterflow unit, the admission is uneven

Also the air ducting according to Figure 6 is not recommended, because the lines of flow are not of the same length. This results in different resistances and different admissions, so that the expected high RWZ is not achieved. Thus, the possibilities of air guidance shown in Figure 7 must be assessed.



			
<p>a) The condensate is conveyed into the cold zone by gravity and flow. If a lot of condensate precipitates, the risk of freezing is reduced. If little condensate precipitates, the freezing process is faster.</p>	<p>b) The condensate can only leave the exchanger with great difficulty due to gravity; the water can back up. This increases the risk of freezing (unless a great deal of condensate precipitates).</p>	<p>c) The condensate is transported to the warm zone by gravity against the flow; the danger of freezing is reduced.</p>	<p>d) The condensate is transported to the warm zone by gravity and flow; the risk of freezing is lower.</p>
<p>1 = Giving off heat 2 = Absorbing heat</p>		<p>⇨ = Condensate ▵ = Cold corner</p>	

Figure 7: Possible air ducting for the counterflow unit

3.2.4 Horizontal configuration (plates horizontal)

With the installation positions and air ducting considered so far, it was always assumed that the plates were vertical. If, however, they are arranged horizontally, some special features must be taken into account, because

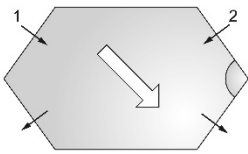
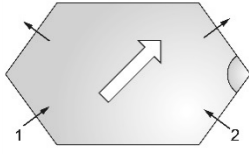
- the condensate drains out without any control;
- condensate can get from the extract air side to the fresh air side through the smallest leakage;
- the aluminium plate heat exchangers may be damaged by the weight of the ice when freezing occurs;
- condensate droplets are easily carried along with the air stream, which is why droplet separators are useful.

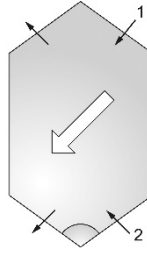
It must also be taken into account that condensate remains on the plates when the system is switched off and can freeze when the fresh air is cold. Experience has shown that freezing problems are much more common with horizontal designs than with vertical ones. This mounting position is therefore not recommended for condensation and the risk of freezing.

3.3 Structure in the plate heat exchanger

The internal structure of the exchanger has a large influence on the possible freezing of a plate heat exchanger; we distinguish between two cases (Figure 8):

Open plate heat exchanger

In the exchanger, both the air and the condensate can flow in all directions. The plate spacing is usually ensured by knobs or similar.

Duct heat exchanger

Here – at least on the extract air side – the air is guided in tubes (round, triangular or square). This also applies to the condensate, which reduces the influence of gravity.

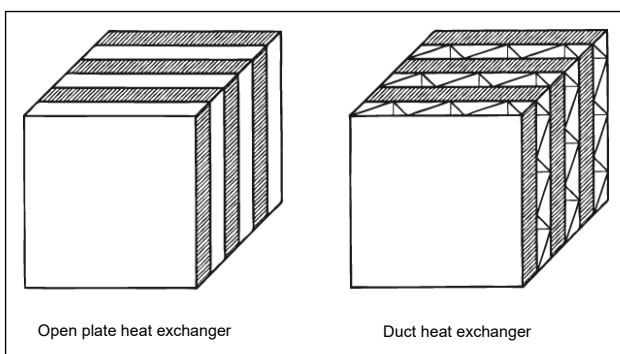

Figure 8: The internal structure of the plate heat exchanger is a decisive factor for the freezing behaviour.

If the extract air is conducted in ducts or tubes, the effect of icing is different from that of an open plate heat exchanger:

As soon as a duct is frozen at a point, the flow of extract air is interrupted and the tube no longer functions. For example, if the first duct is blocked by ice formation, the second duct is directly exposed to the cold fresh air. It becomes, so to speak, the first channel and also freezes (Figure 9). This consideration is proven by practical results; duct plate heat exchangers generally freeze faster than open plate heat exchangers.

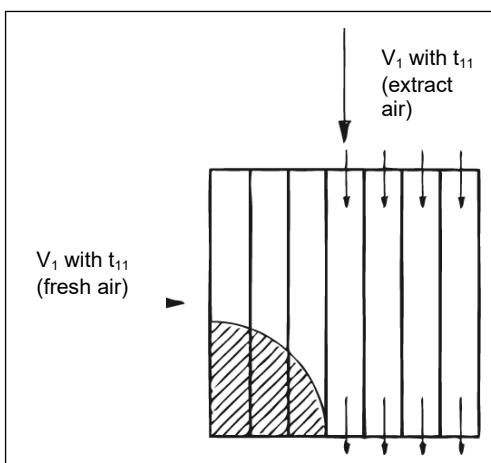

Figure 9: Air flow in partly frozen duct plate heat exchanger

The following insights can be concluded:

- Extract air fans with a steep characteristic curve prevent or delay the freezing of the plate heat exchanger and are therefore recommended.
- Plate heat exchangers which allow a free flow between the plates of the extract air (open plate heat exchangers) have a better operating behaviour than duct plate heat exchangers; these tend to freeze up.
- In general, no recommendations can be given with regard to installation position and air ducting. Rather, it is necessary to consider which solution offers advantages on a case-to-case basis according to condensate quantity and extract air speed.

4. Possibilities for avoiding ice

First and foremost, it should be noted that in practice the icing problem, especially for open plate heat exchangers, hardly plays a role. Reasons for this are:

- Most systems do not work during the night, i.e. not at very low outdoor temperatures.
- Temporary partial freezing is tolerated (or not noticed at all) by the operator.
- The conditions on which the calculation is based do not occur in practice. This applies in particular to the humidity of the extract air, which in winter is often less than 4 g/kg.

If - for whatever reason - it must be ensured at all times that the plate heat exchanger will not freeze, the following measures are possible to prevent freezing:

- Preheating the fresh air
- Change in mass flow ratio
- Defrost switch

It is characteristic of all these measures that the overall efficiency of heat recovery, as well as the fresh air flow, is reduced. From an economic point of view, however, this is of little importance, as the risk of freezing normally occurs only during a few operating hours per year.

4.1 Preheating the fresh air

Freezing can be prevented if the fresh air is always warmer than the freezing limit. This is possible by adding extract air (mixed air operation) or by preheating (hydraulic or electric). It is important that preheating is only necessary in the area of the cold corner, i.e. the size and power of the preheating can be reduced. As this method requires a relatively large installation effort, it is rarely used.

Incidentally, additional heating of the extract air is theoretically also possible, but not recommended from an energetic point of view.

4.2 Reduction of the mass flow ratio by means of a bypass

If part of the fresh air is supplied via a bypass, the mass flow ratio changes: little cold air can no longer cool much warm air to the point where the condensate freezes (Table 2). However, it must be taken into account that $m_2 : m_1$ must be less than approx. 0.5 in order to achieve an effect. The reason is that there is always a strong cooling of the extract air in the area of the cold air inlet.

m_2/m_1	t_E
1.0	- 6.9
0.8	- 8.4
0.6	-10.4
0.4	-13.6

Table 2: The risk of freezing also decreases with less fresh air ($t_{11} = 20 \text{ }^\circ\text{C}$, $rH = 30 \%$, $RWZ = 0.7$)

This measure is often used because according to European Regulation EU 1253 a bypass is necessary to regulate the performance. The additional effort is therefore low; it is limited to the necessary control function. From an energy point of view, this solution is not very favourable, since the overall efficiency is greatly reduced by bypassing a large part of the fresh air. Important: The bypass must be arranged in the fresh air flow; an extract air bypass is not suitable as icing protection.

4.3 Defrost switch

This process allows the ice to form and then melt again with a special circuit. If the plate heat exchanger is frozen to a certain degree (this is usually determined by increased pressure drop), the fresh air flow is switched off. Now the plate heat exchanger is only exposed to the warm extract air. This defrosts the ice and unblocks the heat exchanger again. This solution is very simple and cost-effective, but requires the supply air to be switched off briefly (approx. 3 to 5 minutes).

5. Control systems

There are three common ways of controlling or regulating the various ice avoidance processes:

5.1 Outdoor temperature

Depending on the fresh air temperature, the bypass damper, for example, is opened to a certain value. It is therefore a simple control function (\rightarrow no regulation), i.e. the energy use is not optimal. However, if it is considered that the icing protection is only necessary during a few hours a year, this disadvantage is tolerable. Advantages are the robust function and the low additional costs.

5.2 Extract air temperature in the cold corner

With a temperature sensor in the extract air, installed in the area at risk the cold corner close to the exchanger, the icing protection circuit can be continuously regulated. For example, a pre-heating function or bypass is controlled so that the exhaust air temperature in the cold corner is 0 °C. This prevents freezing with little effort and makes maximum use of the energy of the extract air.

5.3 Extract air pressure drop

The extent of icing can be determined by the increase in the pressure drop. This allows a value to be set via a pressure load cell at which the frost protection circuit goes into operation (2-point control). This control is mainly used for defrost circuits.

However, since the pressure drop also changes without freezing, e.g. due to temperature and dirt, it is difficult to set the correct switching point. Systems with variable flow rate make this even more difficult. The method, which was often used in the past, is rarely used today.

Summary

After considering the various influences and the associated multitude of effects, it is understandable that it is not possible to make a well-founded and reliable statement on the freezing behaviour of plate heat exchangers. However, practical experience, supported by increasingly sophisticated calculation methods, makes it possible to provide planning information and make suggestions for optimum icing protection in specific cases. The solution depends not only on the operating conditions but above all on the design of the heat exchanger and the ventilation system (fan).

Point of contact:

Hoval Aktiengesellschaft
Thomas Richter
Head of R&D Energy Recovery
Email: thomas.richter@hoval.com